

製品名 マット・ちどり格子 (風除室用マット)			
図面名 外形寸法図			
縮尺 1/3	検図	設計	設計日
材質 軟質塩化ビニール	作図	作図日	96.9.6

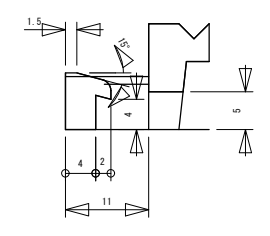

SECT D-D'

B部 (ジョイント:メス) 詳細 S=1/1

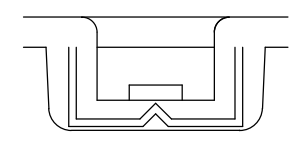
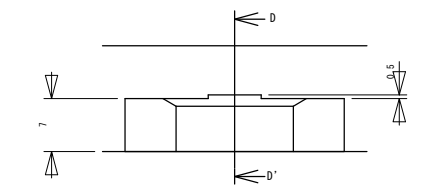
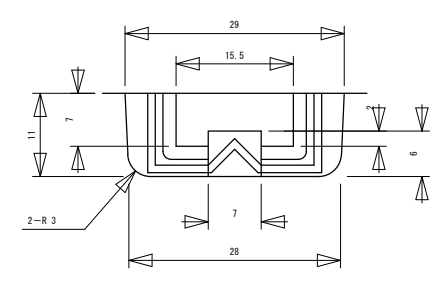
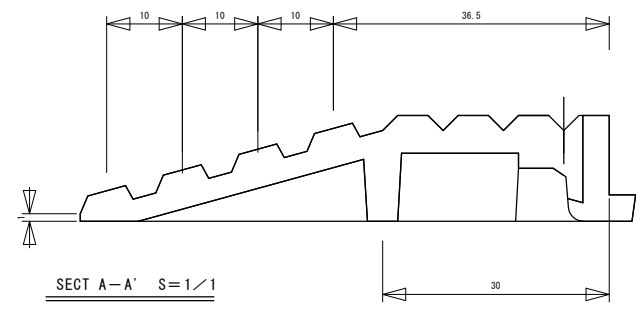
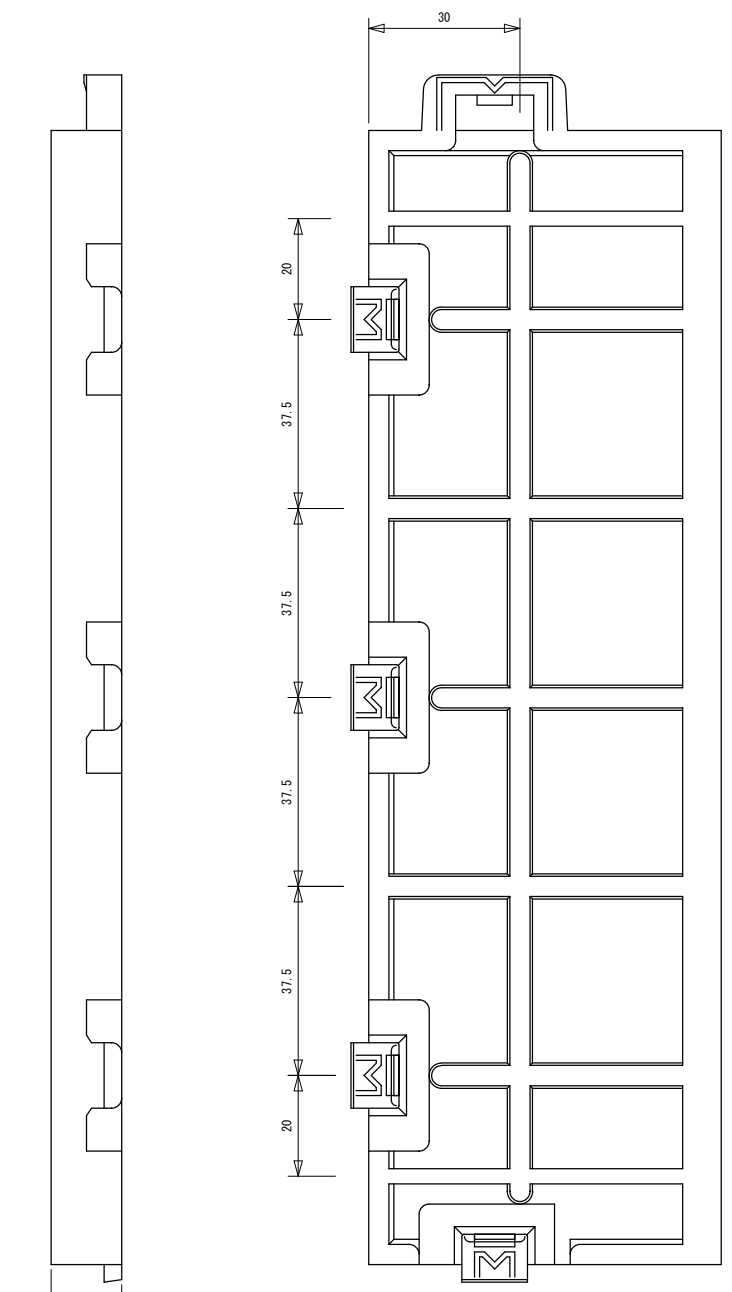
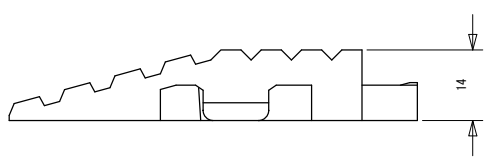
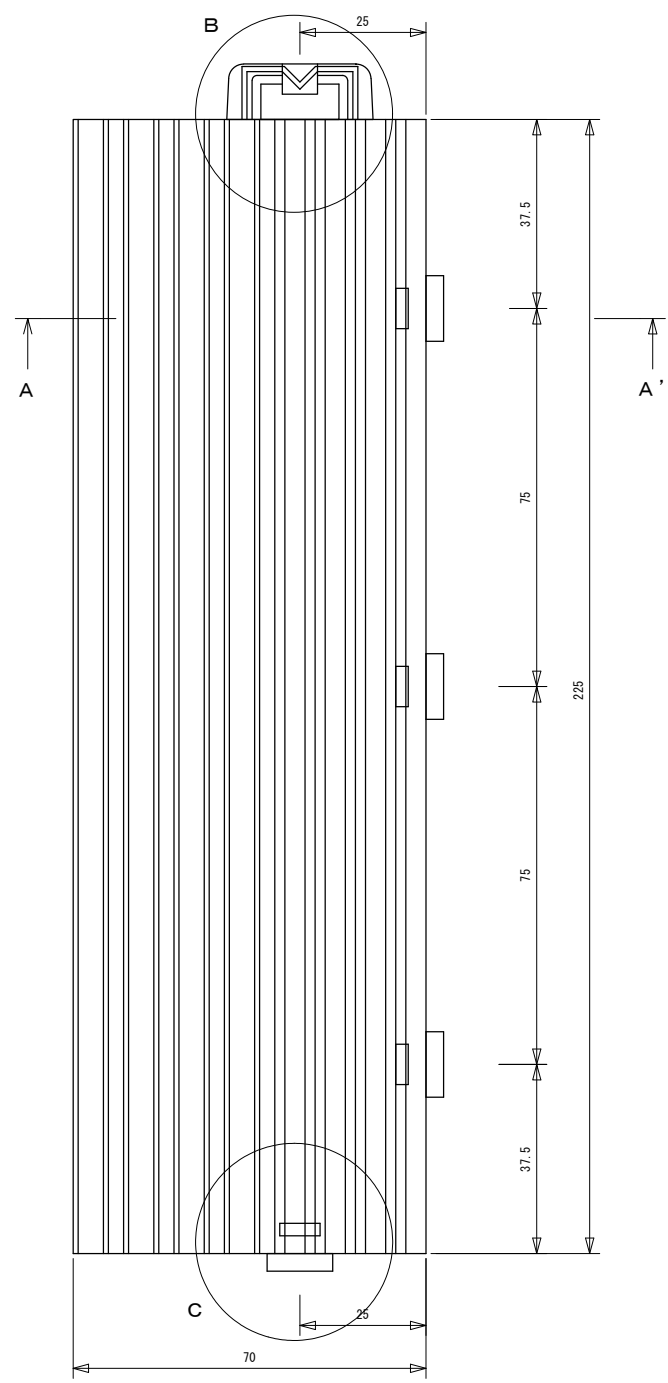
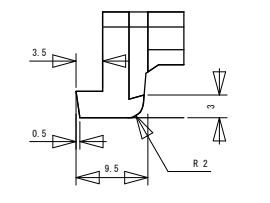
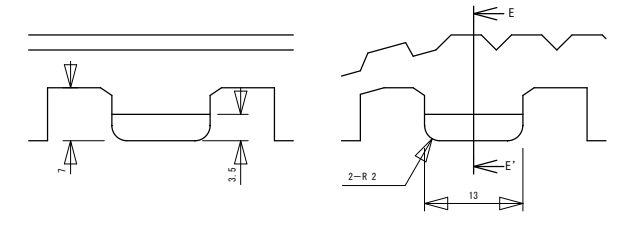
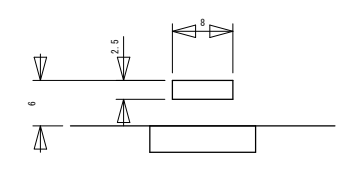

SECT E-E'

C部 (ジョイント:オス) 詳細 S=1/1

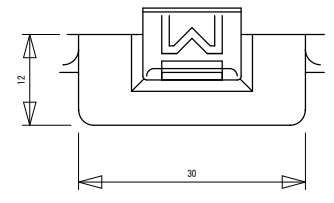

製品名			
マット・ちどり格子用 中フチ (+)			
図面名			
外形寸法図			
縮尺	検図	設計	設計日
2/3			
材質	作図	作図日	
塩化ビニール	仲西	97.10.28	

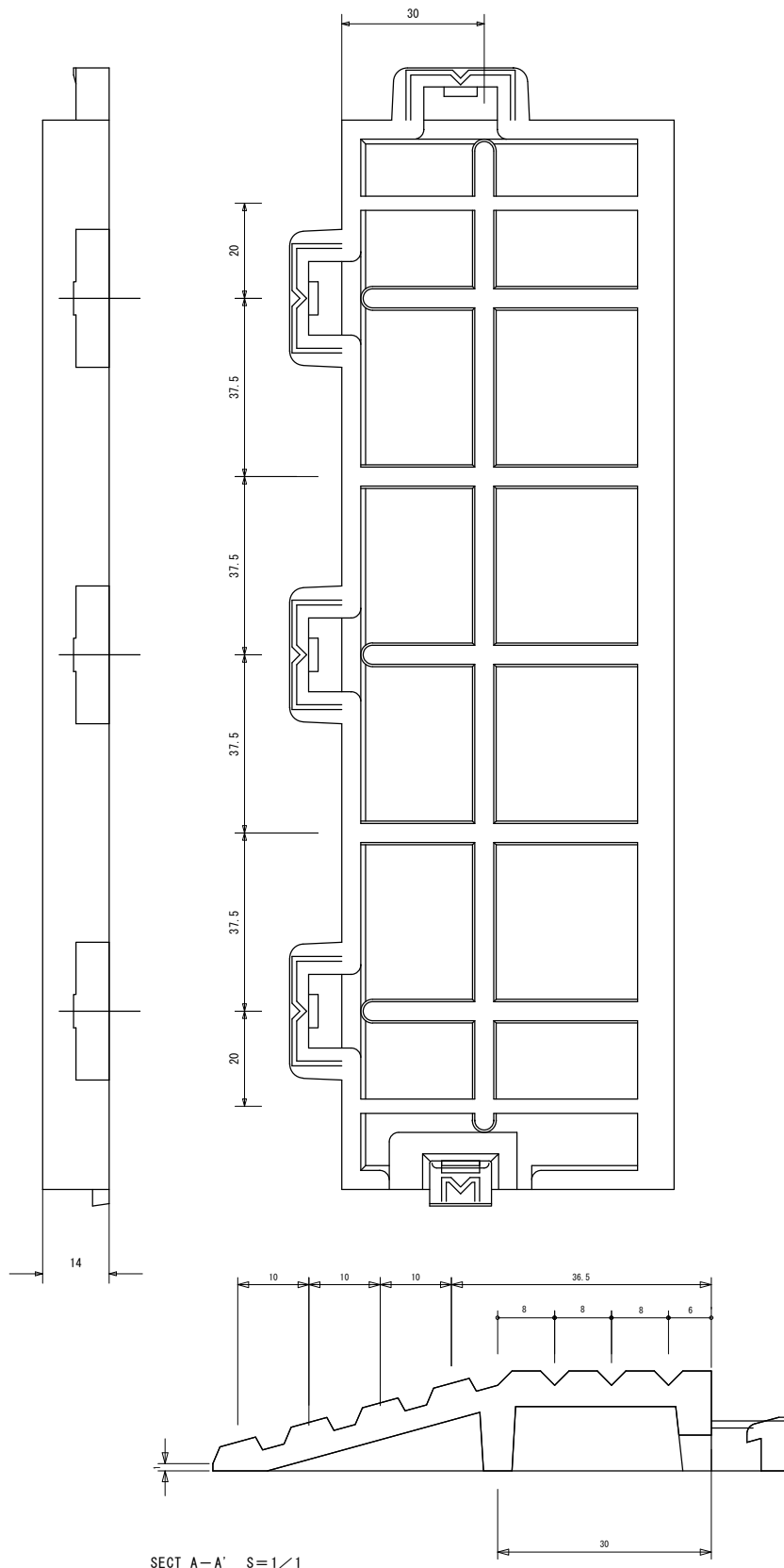
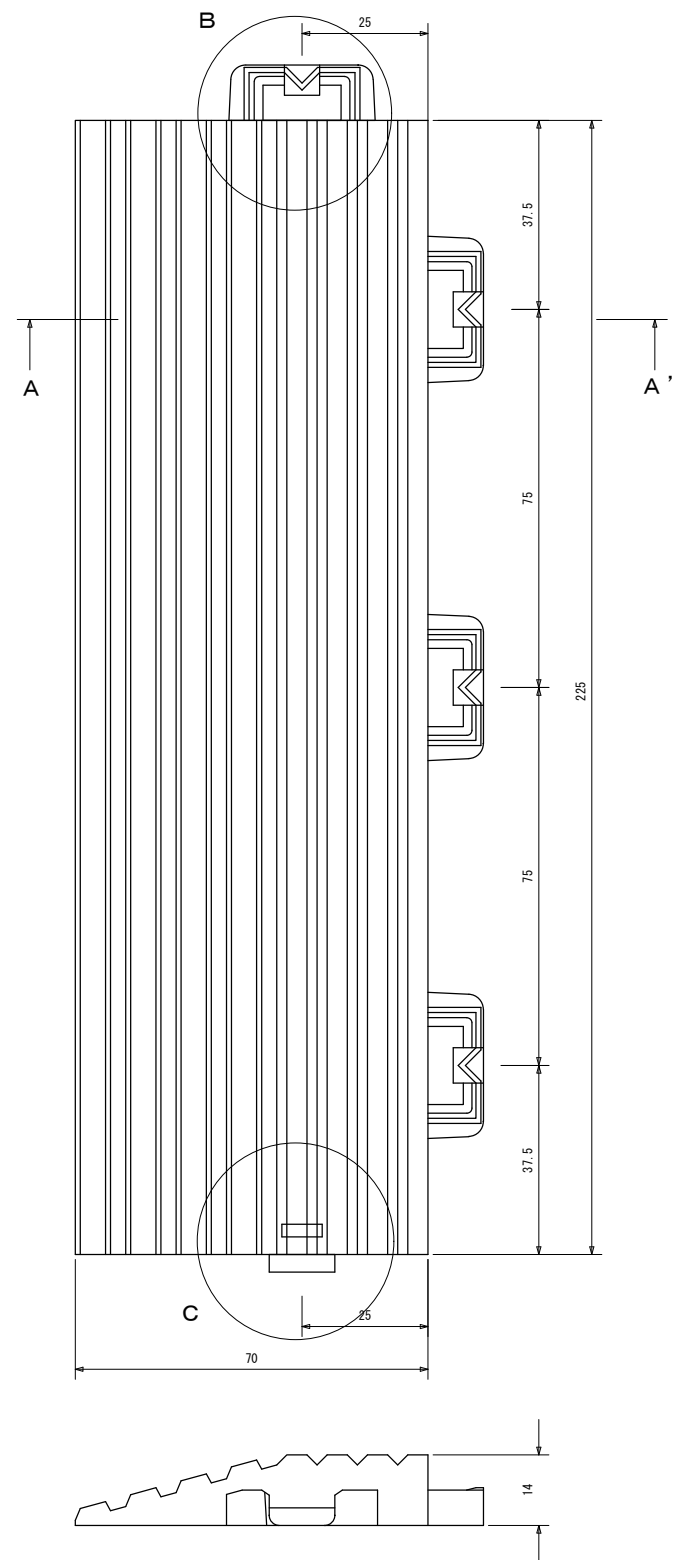

SECT A-A' S=1/1

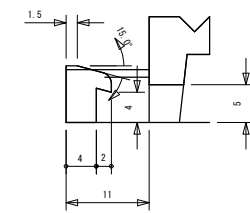
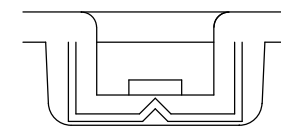
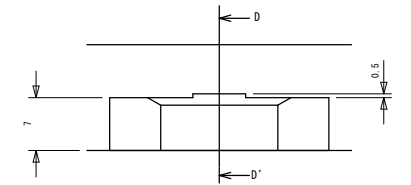
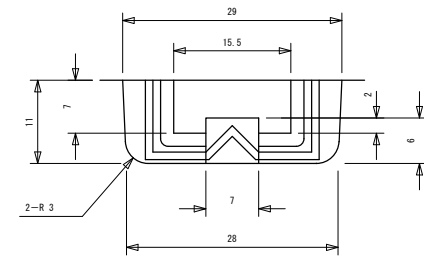

SECT D-D'

B部 (ジョイント: メス) 詳細 S=1/1

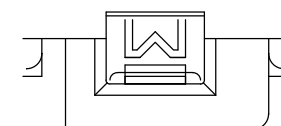
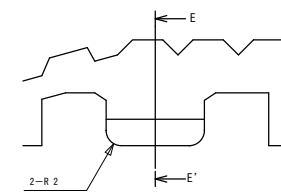
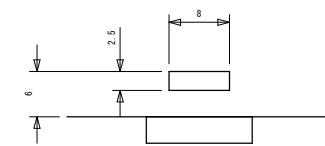

SECT E-E'

C部 (ジョイント: オス) 詳細 S=1/1

製品名			
マット・ちどり格子用 中フチ (-)			
図面名			
外形寸法図			
縮尺	検図	設計	設計日
1/1			
材質	作図		作図日
塩化ビニール			97. 10. 28

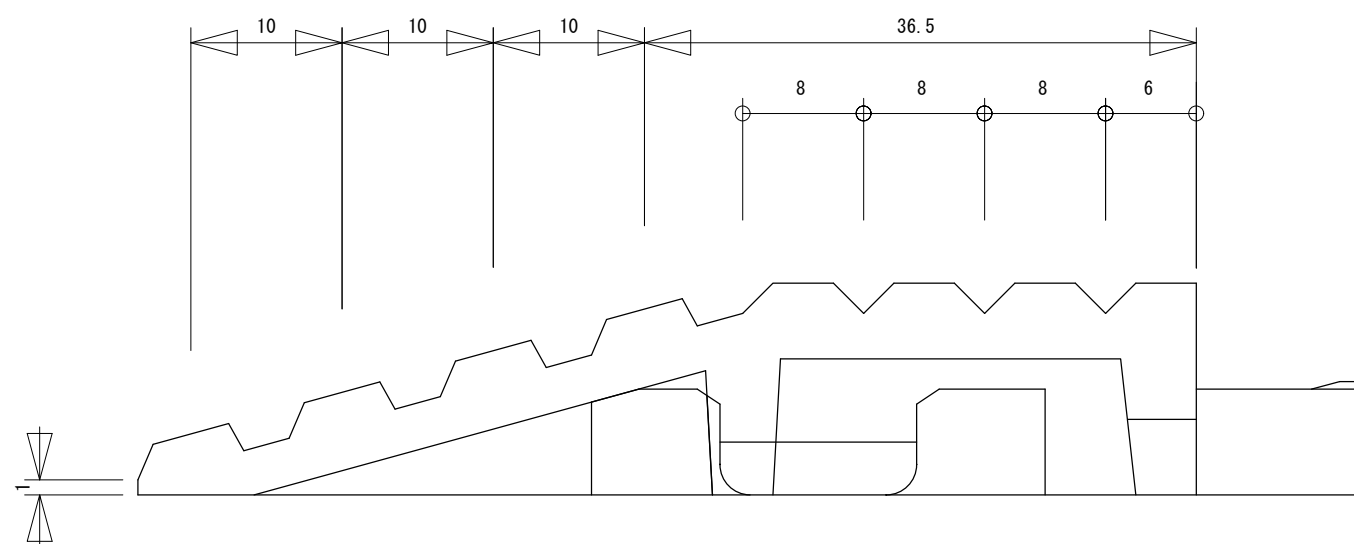
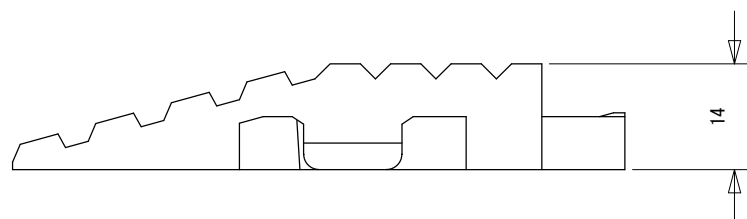
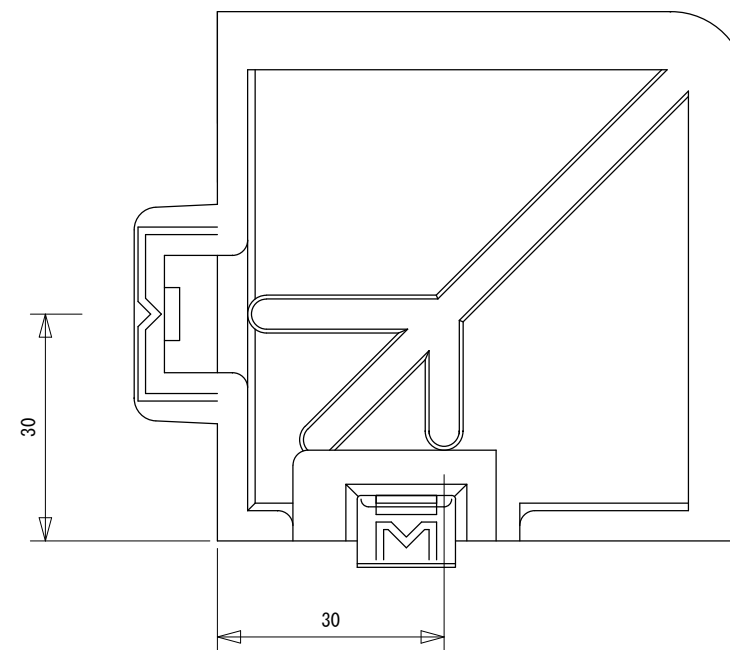
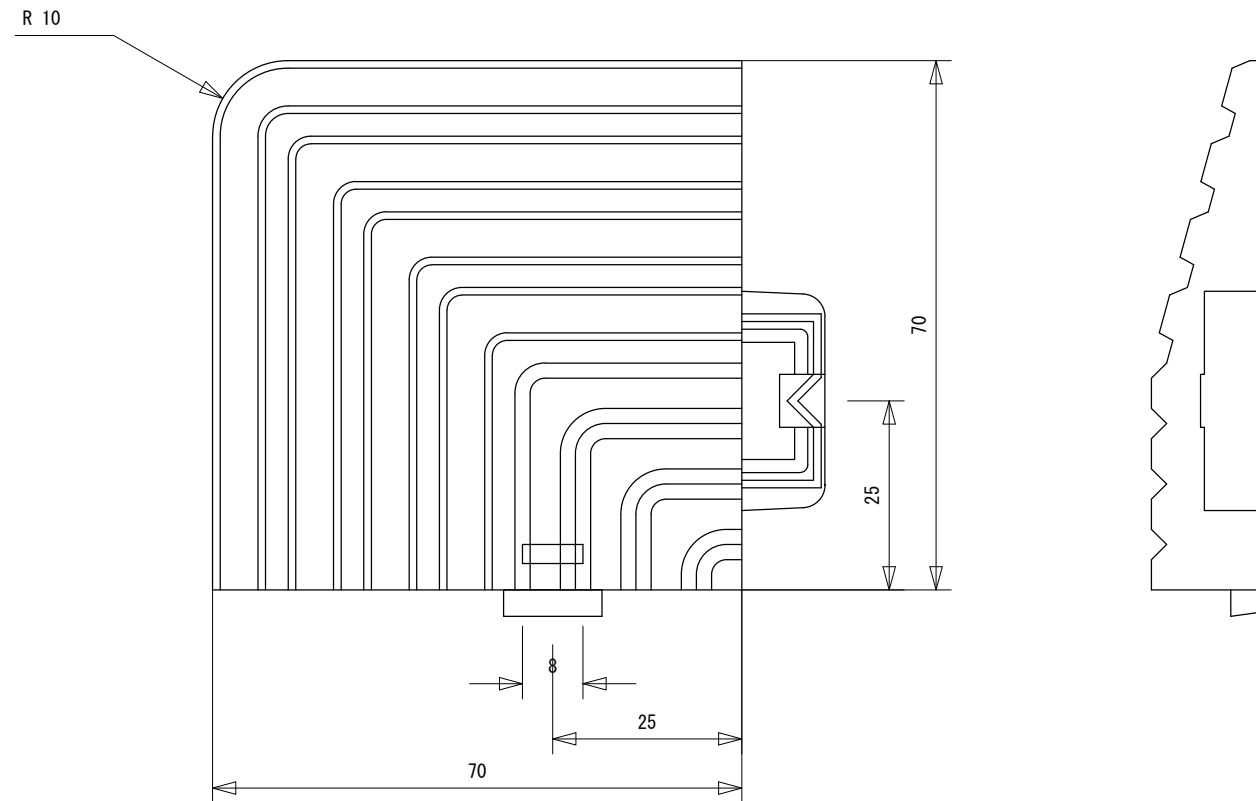

側面図詳細 S=2/1

※ジョイント部寸法は中フチ図面に詳細

製品名 マット・ちどり格子用 コーナー			
図面名 外形寸法図			
縮尺 1/1	検図	設計	設計日
材質 塩化ビニール		作図	作図日 97.10.28



三ツシヤ工業株式会社

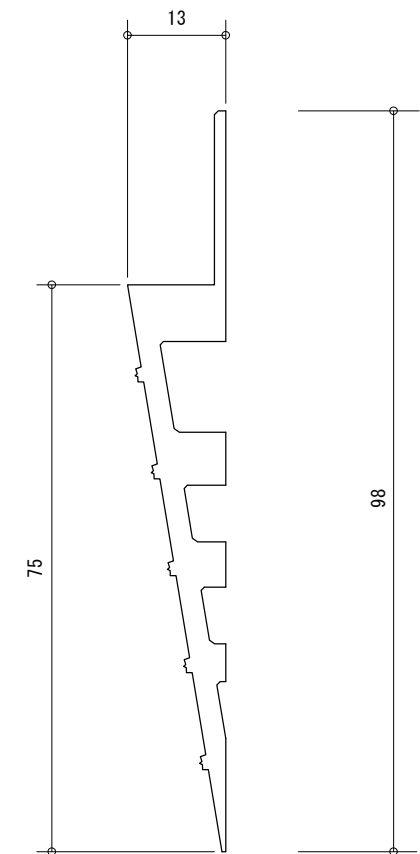
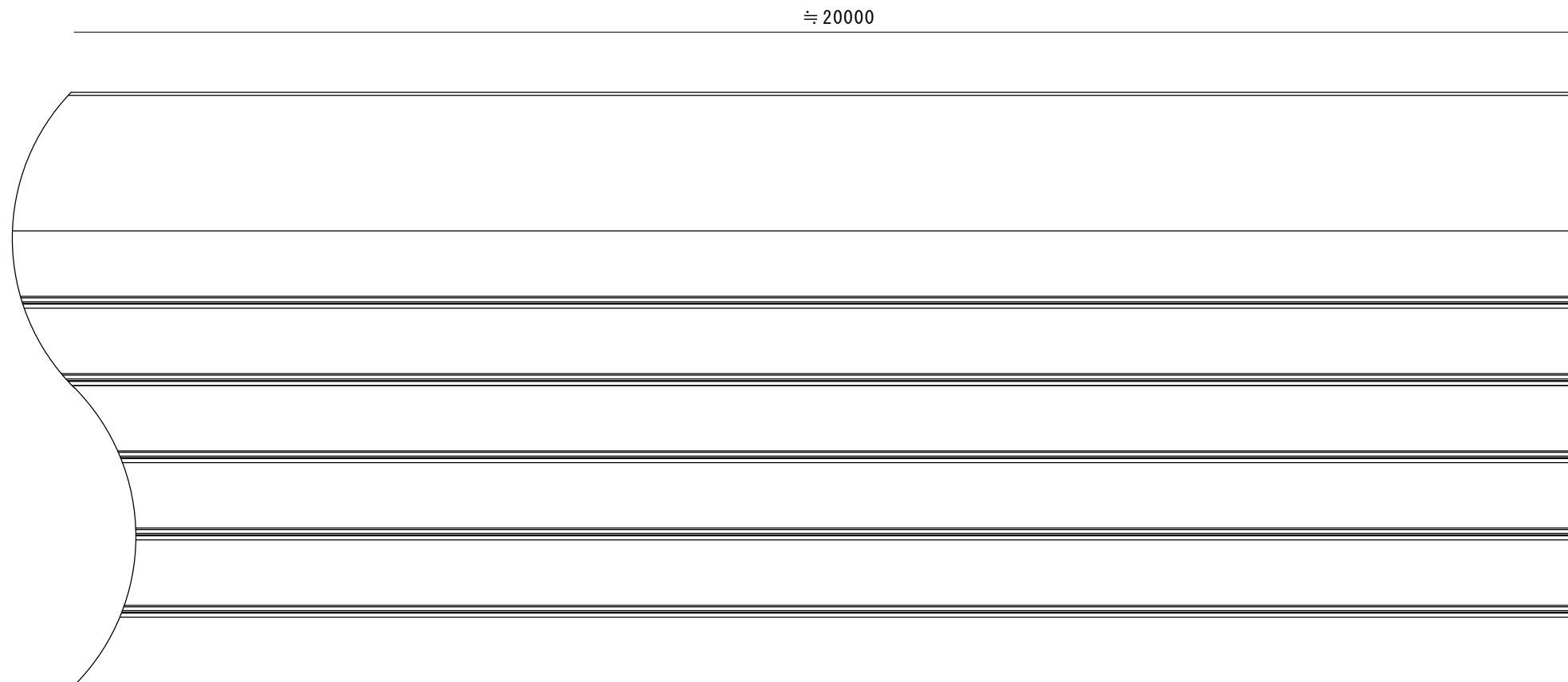

材質：塩化ビニル

現場名 マット・ちどり格子 エッチロール			御 承 認 印 年 月 日
図面名 形状寸法図			
縮尺 1/1	検図	担当	作成日